

NOMINATION OF THE

1870 DENISON BRIDGE

BATHURST

AS AN

**HISTORIC ENGINEERING
MARKER**



Engineering Heritage Committee
Sydney Division
Institution of Engineers, Australia
November 1994

CONTENTS

LOCATION MAP OF FOUR BATHURST BRIDGES	
THE NOMINATION	
OWNER'S SUPPORT	
STATEMENT OF SIGNIFICANCE	3
THE PROPOSED PLAQUE	4
BATHURST	
INTRODUCTION	5
THE COLONIAL HISTORY OF BATHURST	6
THE DENISON BRIDGES	
THE 1856 BRIDGE	11
THE 1870 BRIDGE	14
THE BRIDGE ENGINEERS	17
TYPES OF TRUSSES	18
THE OTHER COLONIAL BRIDGES OF BATHURST	
RANKEN'S BRIDGE	19
THE RAILWAY BRIDGE	21
ROCKET STREET BRIDGE	22
ENGINEERING SIGNIFICANCE OF THE DENISON BRIDGE	25
CONCLUSION	31
APPENDIX	

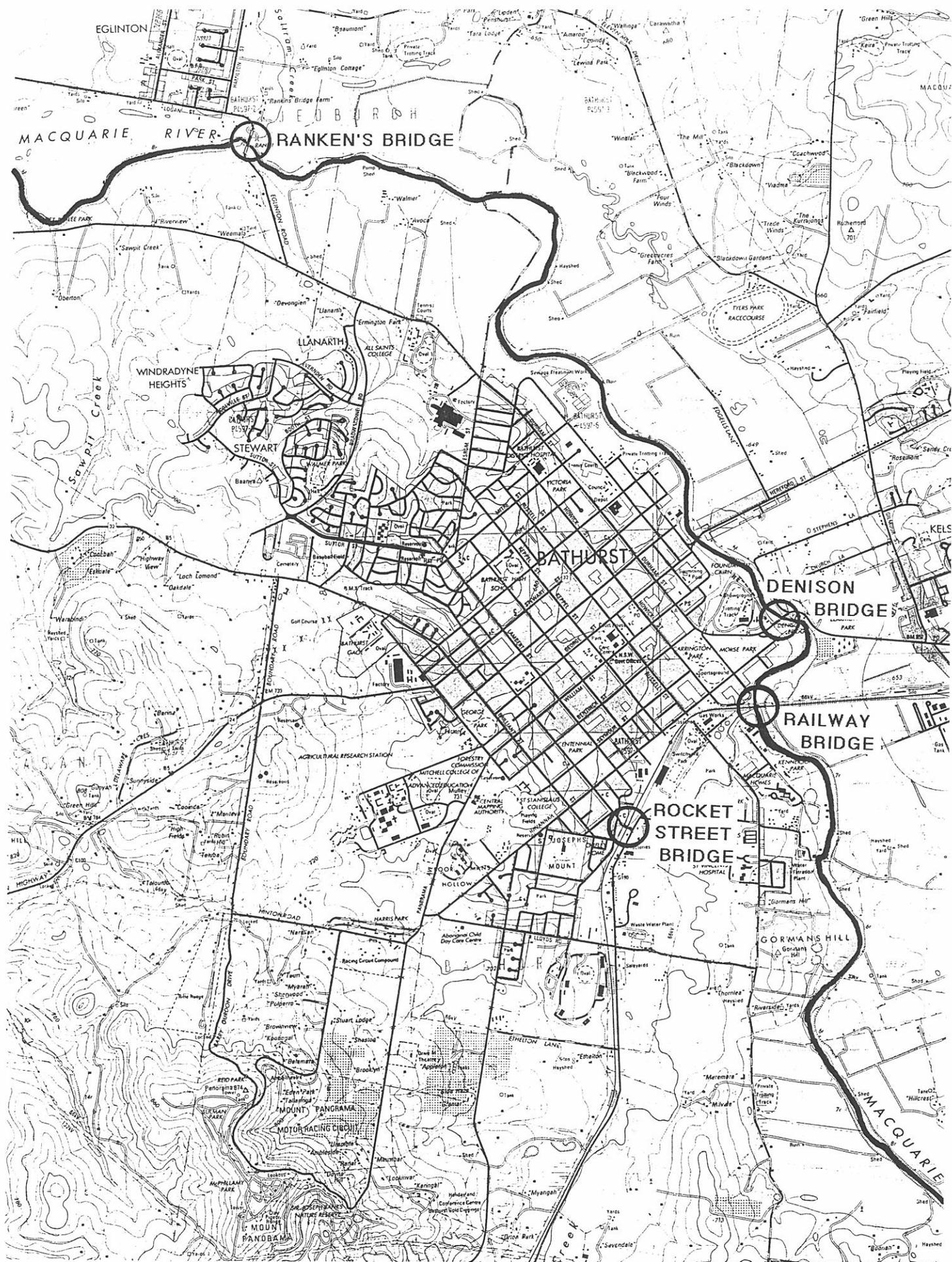

Locations of Bathurst's four significant colonial bridges

Commemorative Plaque Nomination Form

To:
Commemorative Plaque Sub-Committee
The Institution of Engineers, Australia
11 National Circuit
BARTON ACT 2600

Date:..... *November 1994*

From..... *Engineering Heritage*

Committee,

Sydney Division

(Nominating Division or Branch)

The following work is nominated for an *Historic Engineering Marker/~~National Engineering Landmark~~ award:

Name of work *Denison Bridge*

Location, including address and map grid reference if a fixed work

over Macquarie River, Bathurst, NSW

Owner *Bathurst City Council*

In support of the nomination the following information is provided:

For an Historic Engineering Marker (HEM)

(1) Proposed wording on HEM# *see p4 of the submission*

(2) Justification - please make data as complete as possible.# *see Statement of Significance on p3 of submission*

For a National Engineering Landmark (NEL)

(1) Date of construction (or other significant dates).

(2) Names of key professional personnel associated with the work.#

(3) Historic engineering significance of the work.#

(4) Comparable or similar works (a) in Australia (b) overseas.#

(5) Features or characteristics setting the work above other engineering works.#

(6) Contribution towards the development of engineering and/or the nation.#

For all Nominations

The following documentation is attached in support of the nomination:
(List all documents, photographs, etc, and enclose black and photographs).

The nomination has been discussed with the owner of the work who has indicated
A Conservation Plan has been prepared by Irwin Johnston and Partners; Bathurst City Council will preserve the bridge.
(Include statement regarding owner's attitude)

A copy of this submission has been sent to the Secretary of the

Division at
(For completion by a nominating body other than a Division)

In the event of this nomination being approved the nominating body will organise an suitable presentation/ unveiling ceremony.

.....
(Chairman of Nominating Committee)

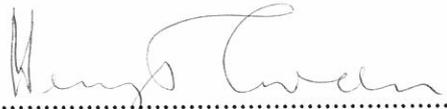
.....
(Secretary of Nominating Committee)

* Delete as appropriate

Where there is insufficient space, attach additional papers

TELEPHONE: (063) 31 1622
FACSIMILE: (063) 31 7211

All Correspondence to
The General Manager
Private Mail Bag 17
BATHURST NSW 2795



Our Ref: WO:KK:B08/06 194092000019
Mr Warren Oliver (063) 336-142

Your Ref:

23 November 1994

Mr B Adam
Irwin Johnston & Partners NSW Pty Ltd
5 Northcliffe Street
MILSONS POINT NSW 2061

Dear Mr Adam

DENISON BRIDGE

I refer to your letter of 15 September, 1994, concerning the proposal to nominate the Denison Bridge for an Historic Engineering Marker.

Council, at its meeting held on 16 November, 1994, considered the proposal and resolved that it wishes the Denison Bridge to be nominated for an Historic Engineering Marker, and that it intends to preserve the structure as such.

Yours faithfully

A handwritten signature in cursive script, appearing to be "C Pitkin".

C Pitkin
GENERAL MANAGER

STATEMENT OF SIGNIFICANCE

In the history and development of bridges in Australia and New South Wales, the 1870 Denison Bridge at Bathurst is particularly significant because

it was the first example of the truly American Pratt truss in Australia, in a country dominated by British bridge technology based on the lattice and Warren trusses.

it is the fifth-oldest metal truss bridge in Australia.

it is the second-oldest metal truss bridge in New South Wales.

it is the oldest Pratt truss in New South Wales.

it is the oldest of the four colonial bridges of Bathurst.

three important colonial engineers, W. C. Bennett, G. A. Morell and P. N. Russell were involved with its design and construction.

its fabrication and erection used substantial amounts of materials and skills already available in the colony with consequent economic benefits to the government.

its structure incorporates an innovative and practical solution to the problem of lateral buckling of the compression top chords of each truss, years ahead of the theoretical solution.

its fabric, through the distribution of the ironwork, displays the types of forces, compression and tension, generated in the members of trusses.

its clean, open arrangement of members and joints made for easy maintenance which contributed greatly to its long service life.

the 123-year service life, interrupted only for a 9-day repair period, contributed significantly to the social stability and growth of Bathurst.

the long trouble-free service life was of considerable benefit to the continuous flow of people and goods between Sydney and the western districts of New South Wales.

THE PROPOSED PLAQUE

HISTORIC ENGINEERING MARKER

DENISON BRIDGE, BATHURST

THIS WAS THE FIRST AMERICAN PRATT TRUSS IN NEW SOUTH WALES AT A TIME DOMINATED BY BRITISH TECHNOLOGY. COMPLETED IN 1870 BY PETER NICOL RUSSELL TO AN INNOVATIVE DESIGN BY GUSTAVUS MORELL IT PROVED THE CAPABILITIES OF LOCAL ENGINEERING SKILLS. ITS CLEAN OPEN CONSTRUCTION MADE FOR EASY MAINTENANCE WHICH ENABLED THE BRIDGE TO CARRY MAIN WEST TRAFFIC FOR 123 YEARS.

(60 words)

DEDICATED BY
THE INSTITUTION OF ENGINEERS, AUSTRALIA
AND THE BATHURST CITY COUNCIL 1995

What is it ?	Denison bridge
Who did it ?	Peter Nicol Russell and Gustavus Morell
Engineering significance ?	First Pratt truss in NSW, demonstrated local skills
Social impact	Carried main west traffic for 123 years

BATHURST

Introduction

On May 7, 1815 Governor Lachlan Macquarie proclaimed the settlement of Bathurst on the western side of the river, naming the settlement after Lord Bathurst, the British Secretary for War and the Colonies. This event took place only two years after the famous crossing of the Blue Mountains by Blaxland, Wentworth and Lawson, and George Evans' naming of the river as the Macquarie River. Bathurst was, therefore, the first settlement west of the Great Dividing Range and predated the establishment of most of our coastal capital cities.

Bathurst became and still is the "gateway to the west" by road and by rail. It has a rich and influential colonial history that is easily recognised through its collection of buildings and other components of its built environment. The 1870 Denison Bridge is an important element of that history.

In order to provide an historical backdrop for the Denison Bridge, and its three equally significant companions, the following short history of Bathurst has been prepared based on Bernard Greaves' *The Story of Bathurst* and historical notes by Theo Barker of the Bathurst District Historical Society.



1. *Old Government Cottage, Bathurst, c1817 is one of the oldest buildings in NSW.*
(Originals of photographs by Don Fraser unless otherwise stated)

The colonial history of Bathurst

The first 80 years of Bathurst's history has four distinct periods, initially the 30-year pastoral period preceding the gold rushes, the hectic years of the rushes 1851 - 1860, followed by settling down and establishing a township 1860 - 1876, and finally a period of consolidation 1876 - 1899.

Right from the beginning, engineering infra-structure was an important part of the settlement process. A track-cum-road was built across the mountains by William Cox's party in six months starting at Penrith on 18 July 1814 and reaching Bathurst on 14 January 1815. The Governor and his retinue of thirty-seven travelled by it to Bathurst for the proclamation. However, the site was not available for general settlers because Macquarie had forbidden settlement on the western side of the river. Only officers, soldiers and convicts lived there. So Bathurst began as a stronghold and military outpost, the civilian settlers lived in Kelso on the east side of the river.

This situation continued until 1829 when Governor Darling cancelled Macquarie's Government Stock Reserve Act but it was not until January 1833 that Governor Bourke directed Surveyor Richards to lay out the blocks and streets within the 10,100 acre government reserve on the west side of the river and declared Bathurst to be a "provincial town". By 1841 with a population of 3,599 Bathurst had ceased to be an outpost and had become the centre of a flourishing pastoral district and a base for settlement farther west.

However, the potential of the district was in abeyance because the country between it and the coast was "too difficult a nature for the transport of grain to Sydney". Only the high price for wool justified the slow and expensive journey and under-pinned the prosperity of the district, which enabled Bathurst, by 1850, to become well established as one of the leading provincial centres of New South Wales. By then the town and district had a population of 7,000.

A bridge over the Macquarie River would have been a great asset so as to avoid the difficulties, dangers and delays of fording the river during low water or using punts during high water. At times of floods the river was impassable and the town was isolated for days. But money was needed to improve the road over the Great Dividing Range and to build bridges. Unfortunately, successive Governors had limited funds for public works.

The initial source was gold !

The story of the discovery of payable gold in the Bathurst district in 1851 is well documented in other publications. What concerns this report is the impact of the discovery on Bathurst (and on New South Wales as it affected Bathurst) and how this led to the construction of the first two bridges over the Macquarie River.

It was gold that changed Bathurst from a sleepy provincial town into a prosperous and important centre. Initially, the town gained little from the gold rush because the road to the goldfields at Sofala turned north at Kelso and the lack of a bridge meant poor access to the business and other facilities of the town. But with so much money around, even a modest share was good for the town. By the mid-1850s there was considerable activity in buildings and civic development, and there was a general improvement in the town amenities.

However, communication was still poor. The movement of goods between Sydney and Bathurst suffered long delays as bullock teams were frequently bogged, particularly during each winter. And at the time there seemed to be no practical route for a railway through the precipitous country of the Blue Mountains.

But persistence and money had their rewards when in January 1856 two bridges were completed over the Macquarie River. The first, opened on New Years Day by Governor Denison, who gave the bridge his name, consisted of five laminated timber bowstring arches built under contract to the Government. The second, a timber beam bridge, was a private venture by George Ranken some 5 km downstream at Eglinton, opened on January 12. Both bridges are dealt with in more detail later in this report. By the end of the decade the Government also began to improve the Great West Road between Springwood and Meadow Flat.

The next significant event in the history of Bathurst was the coming of the railway in 1876, complete with an iron lattice girder bridge (see later) over the river and a substantial railway station building. Both are still in use.



2. The imposing 1876 railway station building at Bathurst.

Although the main gold rush was over by 1860, the goldfields were still a steady source of wealth and Bathurst was able to use this and its continuing pastoral wealth to start putting together the "framework of a community".

The electric telegraph arrived in 1860 and the town became a municipality in 1862. In the same year, Cobb & Co. moved from Victoria and using Bathurst as its base and under the strong management of James Rutherford, it became the famous stage coach enterprise of Australian history. There was also a wide range of business activity during the 1860s and 1870s, banks, professions, factories, newspapers, breweries and hotels, and a photographer.

In the midst of the steady progress, communication by road was severed when the major flood of June 1867 washed away the Denison and Ranken's bridges. Fortunately, the Colonial Government recognised the commercial importance of Bathurst and the need to facilitate the heavy flow of freight and trade through the town, so the design of a high-level flood-free bridge was immediately put in hand and the the present iron-truss Denison Bridge was completed in 1870.

At the same time a replacement for Ranken's Bridge at Eglinton was commenced. It was a combination of timber trusses and timber beam spans and was completed in 1873, but was itself replaced by the present bridge in 1920.

The coming of the railway in 1876, which provided all-weather transport to Sydney in only eight hours, heralded a 20-year period of consolidation. Material development proceeded with an unspectacular, routine yet deliberate pace. For example, the Railway Department completed a large iron-truss bridge over its railway yard in 1889 at Rocket Street which greatly improved communications with areas south of the town, it still serves that function. Also, there was a general broadening and improvement in Bathurst's economic, social, sporting and educational facilities. This was reflected in much of the fine architecture within the city and district.



3. *This corner cottage typifies the fine colonial urban architecture of Bathurst.*

By the turn of the century Bathurst had become the third city of the colony of New South Wales but by 1912 the population was stationary and that of the district was declining. As the Bathurst Times said in 1908 it was "not dead, but sleeping". Progress was renewed after World War I through to the present day but that story is beyond the scope of this report.



4. *The centre piece of Bathurst's colonial architecture, the 1880 Court House.*

THE DENISON BRIDGES

The 1856 bridge

When the public meeting in Bathurst took place in February 1854 to press for a bridge over the Macquarie River on or near the line of the Great West Road, it was the climax of nearly a 40-year wait for "a work for which there had been a crying need ever since 1815". There was despair over the Government's intentions so in March the Bathurst Suspension Bridge Company was publicly announced with a proposed capital of 10,000 pounds. (The word "suspension" does not refer to the modern form of cable suspended bridge. Such a bridge was quite unnecessary for the site and well beyond the technical resources of the day. Instead, it simply meant a traffic deck suspended above the river by some contemporary form of structure).

The Government response was immediate with an official arriving from Sydney on April 1 to select the site. It was proposed to build the same type of bridge that had just been completed at Yass, figure 5, and in November a team of sawyers and carpenters arrived from Yass to start the project. Driving of piles began during January 1855 and the bridge was opened a year later.

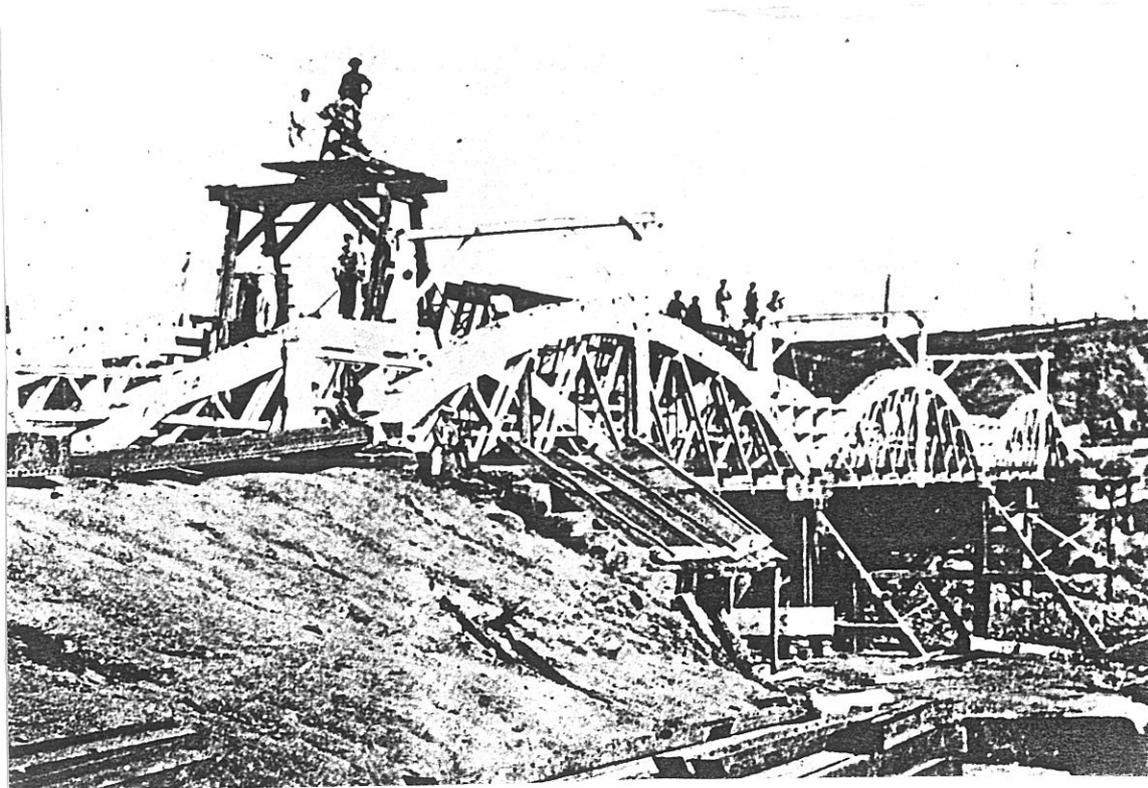

5. *The laminated timber arch bridge at Yass prior to its opening on 18 September 1854. Note the three sets of arches per span that created two independent passageways.*

The following report is from the Sydney Morning Herald of December 31, 1855,

PROGRESS OF INTERNAL IMPROVEMENT - OUR PUBLIC BRIDGES
BATHURST BRIDGE

Tomorrow, New Years Day, his Excellency the Governor-General will open the noble bridge over the Macquarie River at Kelso, which must be regarded as a highly important addition to our list of public works. Colonial Architect W. Weaver drove the first pile on 1st January. The bridge consists of laminated arch suspension spans first made applicable at Maitland bridge completed in 1852.

Bathurst Bridge is on piers of massive piles of box and blackbutt, 48 in all, strongly trussed and braced to resist the action of driftwood. There are five spans, three of 90 feet and two smaller. The three longer spans have 18 suspension rods of $1\frac{1}{4}$ inch diameter, the smaller spans have ten bolts. There are three sets of arches per span which divide the road into two distinct 14-foot wide passages which prevents carriage collisions.

The overall length is 380 feet, the overall width is 33 feet and the height above water is 23 feet. Durable material was chiefly 100,000 feet of blackbutt brought from about 30 miles away. Ironwork was supplied from the Government foundry at Glebe.

The bridge was built by day labour under Mr. Downey, who also constructed the Maitland bridge in 1851-52 and the Yass bridge from November 1853 to September 1854. The Bathurst bridge which cost 6,000 pounds has not yet been officially named. The pass between Kelso and Bathurst has been dangerous and impassable in wet seasons. Completion is regarded with the highest satisfaction to all parties in the Western Districts.

The Illustrated Sydney News had previously reported on progress on Nov 11 1884, January 13 and March 24 1855, and official Government reports showed that the cost was actually 11,000 pounds.

Figure 6 shows the Public Works Department drawing of the arch spans and a drawing of an alternate scheme using timber trusses, both "discovered" at the State Archives Office.

The next report in the Sydney Morning Herald of January 5 1856 dealt with the Governor Sir William Denison opening the bridge on New Years Day, the fact that it was a public holiday and 4,000 people attended, and that there was a celebratory banquet. Mr. Downey, again noted as the designer and constructor of the bridge, must have impressed the townsfolk because in the Bathurst Free Press of January 19 there is a list of donations for a testimonial and present to him plus his letter of thanks.

BRIDGE over the MACQUARIE RIVER at BATHURST

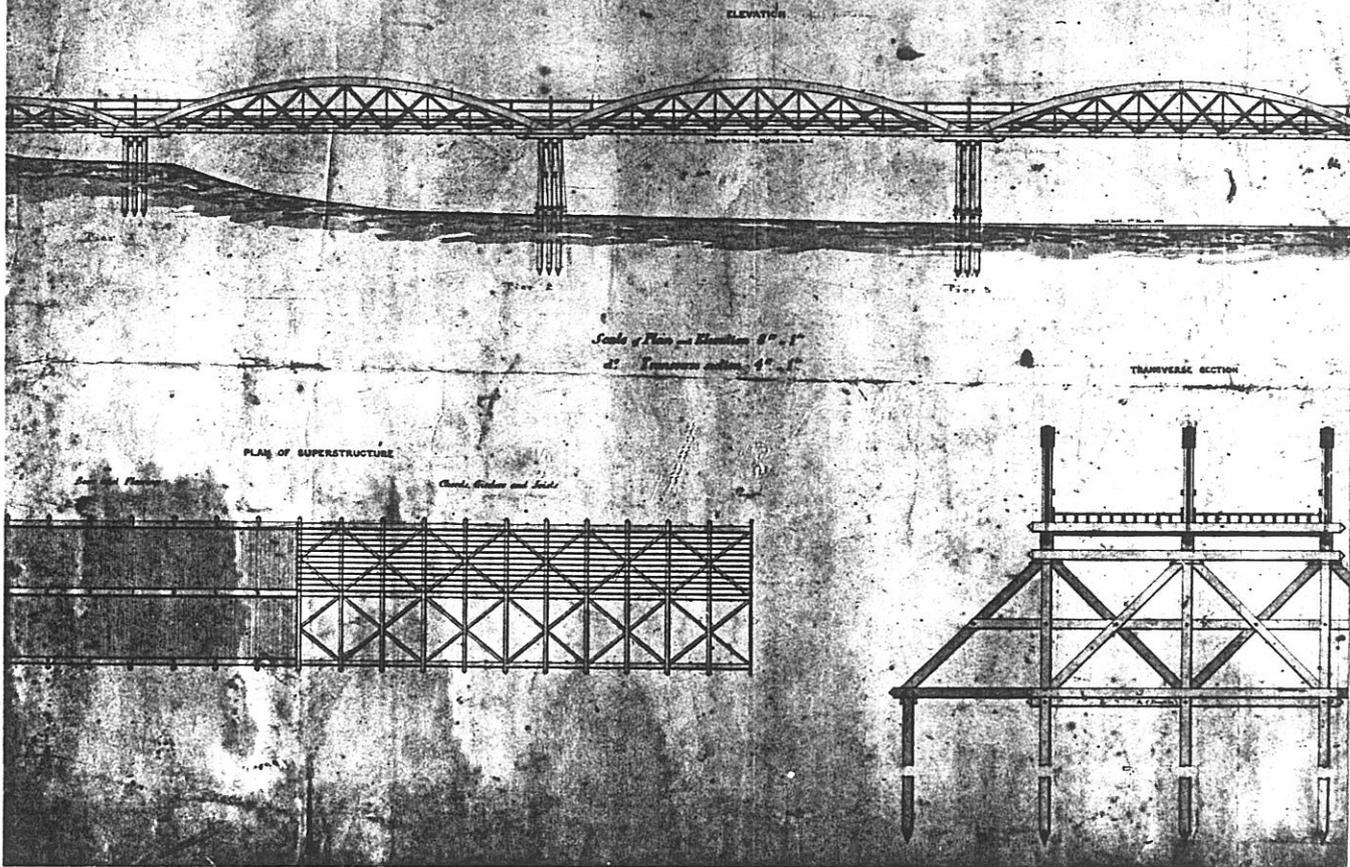

BRIDGE TO BE ERECTED OVER THE MACQUARIE RIVER.

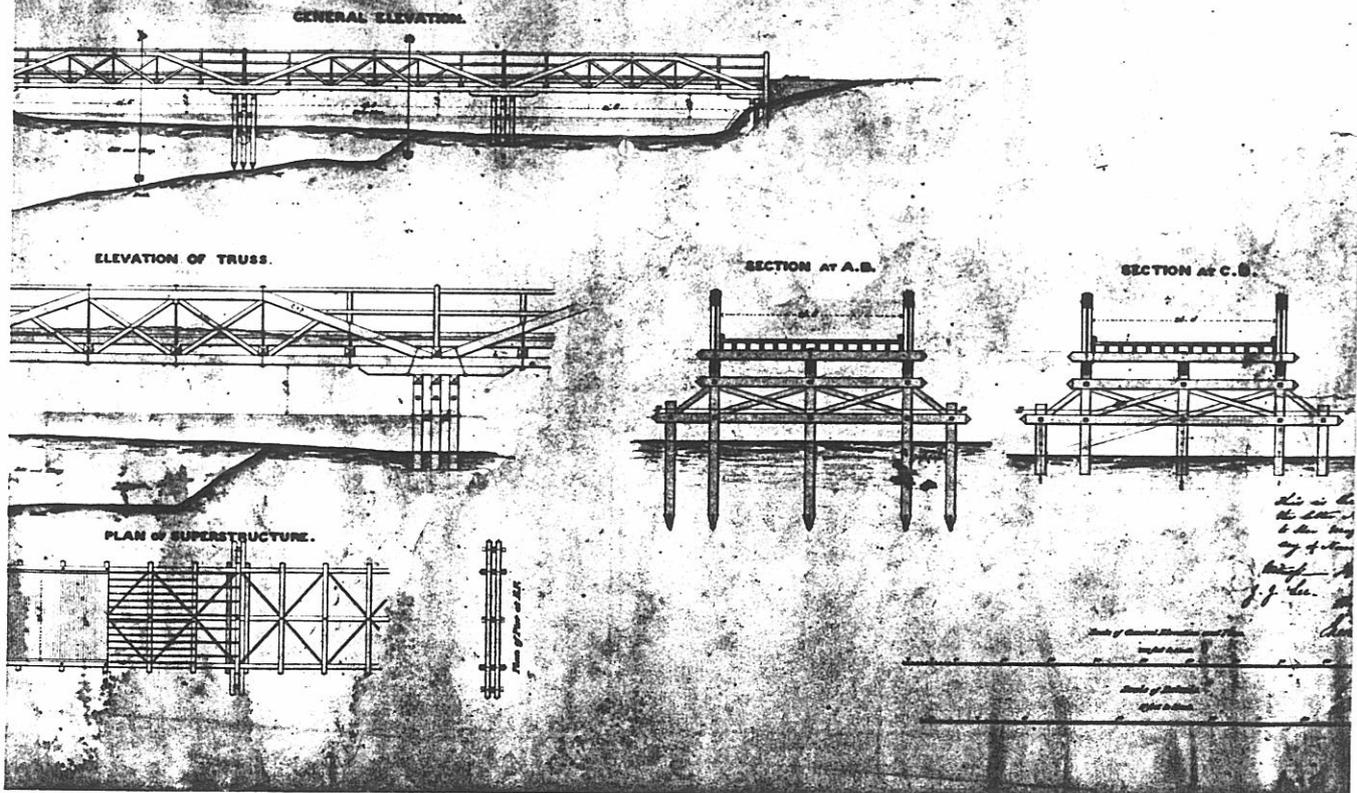

6. 1856 Denison Bridge of laminated timber arches and the timber trusses, not built.

Then on March 11 the Sydney Morning Herald noted that "Howick and Russell Street bridges were completed by Mr. Downey (same man as for the Denison Bridge)" but no details were given. However, it is likely these were small timber beam bridges over Vale Creek in the south-east corner of the town area.

But why were laminated timber arches used when a drawing for a 3-span stone arch had been prepared as early as 1844, figure 7. The answer was supplied in an article in the Sydney Morning Herald on May 26 1856.

Prior to 1852 wooden bridges were rude in construction and of unskillful design. Mr. Weaver, the colonial architect, introduced the laminated arch suspension bridges, the first of this type was the Victoria Bridge over Wallis Creek, Maitland. They were better for sites where stone bridges would be a formidable undertaking. Others of this type are at Yass, Bathurst, Carcoar and at Paddy's River between Berrima and Goulburn.

Sir Thomas Mitchell has drawn attention to "the importance of bridges to the Colony and that roads remained in abeyance for want of bridges. Since convicts had been withdrawn there was a want of labour. Laminated arch construction renders timber sufficiently stable to render that material a convenient substitute for stone. Progress of roads and bridges may be said to have had a second commencement".

Commissioner Bennett's 1865 report shows that the Carcoar and Paddy's River bridges were in fact timber trusses, so a total of eight laminated timber arch bridges were built in New South Wales - Wallis Creek, Maitland 1852, South Creek, Windsor 1853, Yass River, Yass 1854, Macquarie River, Bathurst and Queanbeyan River, Queanbeyan 1856, Peel River, Tamworth 1861, Murrumbidgee River, Wagga Wagga 1862 - and over the Macdonald River, Bendemeer in 1874. Unfortunately they all had serious technical faults and became difficult to maintain, so they were replaced within 30 years of their constructions, if not destroyed earlier as happen to the Denison Bridge at Bathurst which was washed away by the great flood of June 1867.

FOR A BRIDGE ACROSS THE MACQUARIE RIVER AT BATHURST. DRAWING NO. 2.

*James Gowrie
 of the Macquarie River
 Bathurst*

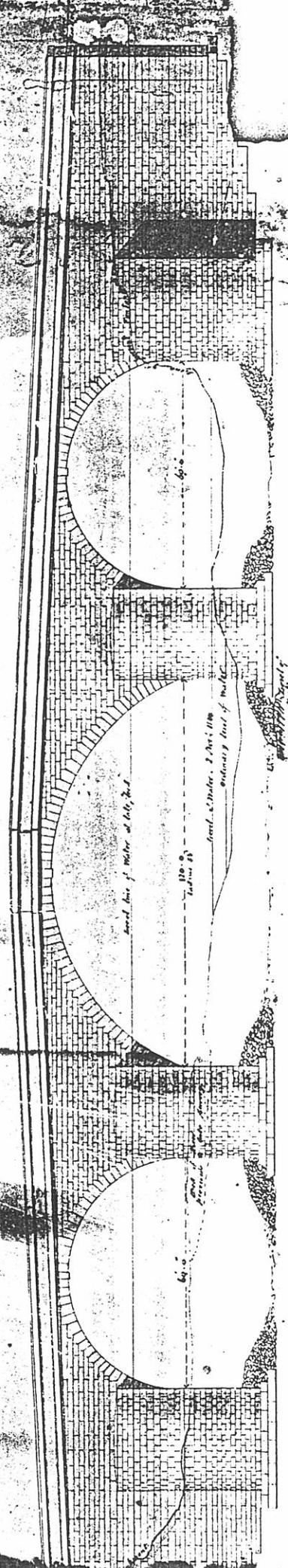

ELEVATION.

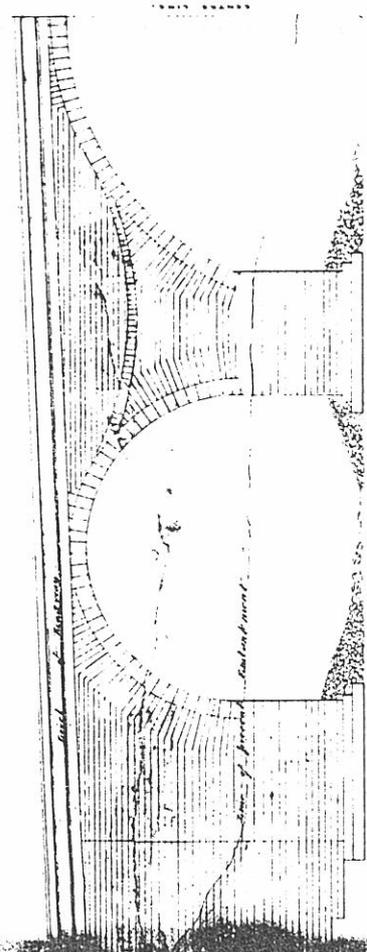

LONGITUDINAL SECTION THROUGH CENTRE OF BRIDGE.



TRANSVERSE SECTION THROUGH CENTRE OF BRIDGE.

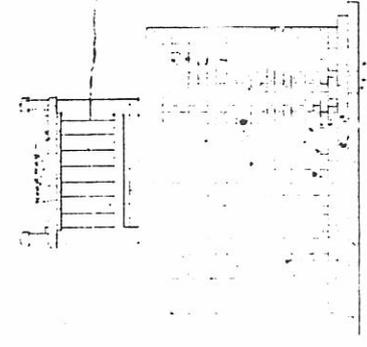

TRANSVERSE SECTION THROUGH ABUTMENT AND ROAD.

7. The 1844 scheme for a stone arch bridge. (RTA)

The 1870 bridge

This bridge is the second-oldest metal truss bridge in New South Wales whereas the Prince Alfred Bridge over the Murrumbidgee River at Gundagai was completed in 1867, see O'Connor's *Register of Australian Historic Bridges* , but note that his 1861 entry for Muswellbrook should be 1879. However, if the types of trusses are taken into account, a British Warren truss at Gundagai and an American Pratt truss at Bathurst, then the Denison Bridge is the oldest of its type in New South Wales. The differences in truss types will be explained in the section Types of Trusses.

The Denison Bridge has been CLASSIFIED by the National Trust (NSW) and is on the Interim List of the Register of the National Estate.



8. *Two of the three Pratt trusses that comprise the main crossing of the Macquarie River, Bathurst. The third span can be viewed from the other bank.*

Planning for this bridge was begun by William Christofer Bennett, Commissioner and Engineer for Roads, in late 1867 shortly after the washaway of the 1856 bridge in June. His decision to adopt a high-level metal truss bridge was based on a combination of technical, economic and political factors. For example, the poor performance of laminated timber construction ruled against its reuse, the development of timber trusses was proceeding cautiously but as yet the spans were considered too short, recent floods such as those in 1867 had demonstrated the need to place bridges above the highest expected

flood, bridges were expensive items to lose and rebuild, and the economic cost of a lost link to the local community and to the colony could be very large.

Also, Government policy was aimed at ensuring that the wealth of inland New South Wales flowed eastwards to Sydney rather than south to Melbourne or south-west to Adelaide. So, building better main roads and large durable bridges to carry them over major rivers was seen to be good long-term economic management and, it was good politics because it showed the country regions that the Sydney-based Government cared about them and at the same time it created a physical bond across the Great Dividing Range.

The successful 123-year service life of the bridge is evidence of the veracity of those factors.

In 1982, Lynn Evans (Chief Engineer for Bridges, Department for Main Roads) researched the history of the 1870 Denison Bridge. The following information is based on his notes (National Trust file) supplemented by the author from other sources.

The drawings and detailed calculations for the bridge were made by Gustavus Alphonse Morell, assistant engineer to Commissioner Bennett, and his signature appears on the copies of those drawings in the Appendix, usually towards the bottom left corner. His decision to use an American type truss in a colony dominated by British engineering practice is significant but comment will be deferred to the section Engineering Significance of the Denison Bridge.

However, the choice of pairs of braced cast iron cylinders, carried down to rock, was the standard practice of the day for major bridges, road or rail, and continued to be so for the next 30 years.

The Governments of that era (they changed frequently) had a common policy of requiring that as much local materials and skills be used in public works as possible so as to minimise expensive imports. Consequently, Morell's design was such that local firms could supply most of the iron, fabricate it and erect the bridge. This objective was largely realised because iron bars were supplied by the Fitzroy Iron Works at Mittagong, structural shapes were formed from it at the Pyrmont Rolling Mills and the fabrication/erection was carried out by the Sydney company P. N. Russell & Co., (Commissioner Bennett's 1870 Report, Illustrated Australian News October 10, 1872 and a memo on DMR file 5/30.12).

Completed at a cost of 18,818 pounds "in much less time than imported work", the bridge consists of six timber beam approach units of 6.7m (22 ft) span and three iron trusses, two of 33.83m (111 ft) and one of 34.44m (113 ft) spans. Originally there was a timber deck but this was replaced by reinforced concrete slabs in 1981. The bridge was opened by the Governor the Earl of Belmore on the June 1 or 4, 1870 (Sydney Mail June 18, 1870 and Illustrated Australian News October 10, 1872).



9. *The maker's plate on the Denison Bridge, Bathurst.*

The cost-effectiveness of the iron trusses can be gauged from the fact that the accumulated expenditure on the bridge up to 1981 (from RTA file), expressed in raw unindexed dollars is \$253,227 of which approximately 80% was spent on repairs to the timber deck and replacing it with reinforced concrete slabs. The remainder of around \$51,000 was spent on painting the ironwork and on other minor repairs to the trusses which represents an average annual cost of only \$422.

Not included is the emergency funds, in the order of \$70,000, expended to repair one of the trusses damaged by the blade of a road-hauled bulldozer in March 1990. An RTA article in the Appendix describes the technical and social problems caused by the breaking of this essential link. However, the bridge was back in service after 9 days and then continued its function without restrictions, such was the robustness of Morell's design and P. N. Russell's construction, until made redundant by the new bridge in 1992. Bathurst City Council now owns this historic bridge and has commissioned this report.

THE BRIDGE ENGINEERS

Each of the three principals associated with the 1870 Denison Bridge, W. C. Bennett, G. A. Morell and P. N. Russell, had a significant impact on the engineering activities in colonial New South Wales during the period 1850 to 1880. They and their work have an honoured place in the engineering heritage of New South Wales.

The attached biographical sketches of Bennett and Russell are from the Australian Dictionary of Biography and deal so adequately with them that the full texts have been reproduced here. Bennett's portrait was obtained from the Roads and Traffic Authority and that of Russell from Sydney University Archives.

As for Morell, the information comes from a Memoir printed in the Proceedings of the Engineering Association of NSW, Vol IV, 1888-89, but a photograph has not yet been located.

BENNETT, WILLIAM CHRISTOPHER (1824-1889), engineer and surveyor, was born on 4 July 1824 at Rathmines, Dublin, eldest son of Ignatius Bennett, traffic manager, and his wife Alicia, née Garvey. In 1840 he was articled in Ireland where he worked on border surveys and as a surveyor and engineer on railways and drainage works. In 1852 he accepted appointment with Gisborne & Forde to go to South



America and report on the navigation of the Magdalena River, its connexion with the sea by canal and the possibilities of a further canal link with Bogota, capital of Nueva Granada (Colombia). As a preliminary he toured the Rhone and Saône Rivers in France to study methods of river navigation by large boats. After he returned to England from Colombia, he helped to plan a proposed embankment for the Thames. It was not implemented and he went to Ireland where he shared in planning northern and western railways. In 1853 he rejoined Gisborne & Forde in another expedition to Latin America, this time in charge of surveying and exploring the Pacific side of the Isthmus of Darien for the international ship canal. There he also assisted Lieutenant Forsythe and a detail from H.M.S. *Virago* in the hazardous rescue of a missing exploration party of United States navy personnel under Lieutenant Strain.

After a few months in England Bennett went to New Zealand in 1854, looking for work, but left early in 1855. Calling at Sydney on his planned return to England, he met Sir Thomas Mitchell [q.v.], and accepted a position in the Survey Department. Nine months later he became assistant city engineer on sewage works under Edward Bell, holding the office until it was abolished in December 1856. In 1857 John Whitton [q.v.] gave him charge of the Campbelltown railway extension. In August 1858 Captain B. H. Martindale [q.v.] chose him as assistant engineer of main roads to superintend the repair of a flood-damaged bridge at Bathurst. On 1 January 1859 Bennett became engineer to the Department of Roads which he helped to form.

Before resigning in 1861 Martindale had hoped, with the support of W. M. Arnold [q.v.], to make Bennett his successor. However, Bennett had resigned on 1 December 1860, giving as his reason the uncertainty and insecure tenure of public appointments. He went to England, intending to obtain work in India, but learned that he was too old for official appointment. After fruitless inquiries about other possibilities such as Canada and Russia, he returned to Sydney where he arrived in February 1862. He served again briefly in the Railway Department under Whitton, and at the end of the year was appointed commissioner for main roads, a position he held until he retired.

In 1857 Bennett and a subordinate, W. B. Wade, won a competition for designing the Launceston sewerage system. In the field of water supply and sewerage in Sydney Bennett was appointed to special commissions in 1868, 1875 and 1888, and

two standing boards as an additional member. He also served in commissions on Sydney's water supply in 1868, on Hunter River floods in 1869 and on Darling Harbour in 1878, and gave evidence to several select committees on various engineering problems. When a narrow-gauge railway to Mudgee was proposed, his advice to the appointed commission saved the colony from the confusion of two internal railway gauges. Under his direction the main roads of the colony were extended to nearly 6000 miles, the unsurfaced roads to nearly 4000 miles, and the total length of bridges to 40 miles. He was made an associate of the Institution of Civil Engineers, London, in 1857 and a member in 1864.

Letters and testimonials from his superiors, subordinates and friends indicate that Bennett had great ability both as an engineer and as an administrator. In his own words, he was 'naturally, and by habit, anxious and energetic'. In particular he was anxious for assurance of the approval of his superiors, and apt to offer resignation if he lacked it. Yet he distrusted public approbation and avoided limelight. Ambitious in the tasks he was prepared to undertake, he drove his subordinates hard but was loyal and generous in return and made staunch friends among them. In 1872 Sir Henry Parkes [q.v.], speaking in support of an increase in Bennett's salary to £1000, described him in parliament as 'one of the ablest officers in the government service' and asserted that he had been grossly underpaid for his important and competent work. Bennett's own letters hint at another side of his character, a degree of intellectual refinement and developed tastes.

On 15 November 1862 at St Thomas's Church, Willoughby, Bennett married Agnes Amelia, second daughter of Henry Hays, of Cricklewood, Middlesex; they had four sons and three daughters. In 1878 his wife took the children on an extended educational tour of England and Europe, but on 14 June 1881 she died of smallpox at Dulwich, London. Bennett went to England and brought the children back to Sydney. On 12 January 1883, again at St Thomas's, he married Sarah Jane, sixth daughter of Joseph Darling, of Mantaro, Rutlandshire; they had one son and one daughter.

In March 1889, after long suffering from a heart ailment, Bennett sustained an attack but, against medical advice, continued work until June when he had to resign. He remained bedridden at his home, Honda, St Leonards East, until his death on 29 September. He was buried in the Anglican churchyard at Willoughby. His estate was sworn for probate at more than £8000.

MINUTES OF PROCEEDINGS
OF
The Engineering Association
OF
NEW SOUTH WALES,

ESTABLISHED 1870, INCORPORATED 1884;

SYDNEY.

Published by the Association,

7 O'CONNELL STREET.

1889.

(The right of Publication and Translation reserved.)

GUSTAVUS ALPHONSE MORELL arrived in the colony about 25 years ago, and entered the Government service. He was for some time engaged on the planning of the defence works of Sydney, Newcastle and Botany, under the direction of Sir William Jervois and the late Major-General Scratchley. On the completion of these works he resigned and commenced business on his own account in Sydney as a consulting engineer and architect. His services in conjunction with his partner Mr. J. E. Kemp, are identified with a number of the prominent buildings of Sydney. Among these are the Mutual Fire Assurance Company's Offices, at the corner of Pitt and King Streets; Her Majesty's Theatre, Pitt Street; Hill, Clark and Co.'s wool stores, Circular Quay; and various other important buildings. When it was decided by the Government of the late Sir Alexander Stuart to appoint a Royal Commission to inquire into the condition of the railway bridges of the colony, the position of President of the Commission was offered to and accepted by Mr. Morell. The elaborate report and important collection of diagrams which were the outcome of the labours of the Commission were largely the results of his untiring efforts. He was a constant and hard worker, very methodical and painstaking. His death was sudden, though not unexpected by medical attendants; but the announcement came as a shock to the many that knew him, and esteemed him either as a genial and faithful friend or as an honorable and prominent citizen. Mr. Morell was elected a member of the Association in 1870.

RUSSELL, SIR PETER NICOL (1816-1905), ironfounder and benefactor, was born on 4 July 1816 at Kirkcaldy, Fife, Scotland, second son of eleven children of Robert Russell, ironfounder, and his wife Janet, née Nicol. His father and uncle, Alexander Russell, operated the Kirkcaldy Foundry and Engineering Works. When his sons were old enough to enter the business, Robert dissolved the partnership and established the Phoenix Foundry and Engineering Works. Peter went to the Kirkcaldy Grammar School and then worked for his father. A severe financial depression in 1830 decided the family to migrate to Canada, but a friend persuaded them to settle in Van Diemen's Land. In the *Anne Jamieson* they arrived in Hobart Town in June 1832.

Robert sold his 2000-acre grant, which was too densely timbered to be cleared, and, assisted by his sons Robert, Peter and John, started a general engineering and foundry business which grew for six years. Because of limited opportunities the family moved to Sydney in 1838, leaving Peter to wind up the business. After Robert retired his sons established Russell Bros in Queen's Square, with works built on the banks of the Tank Stream. They benefited from Robert's experience and advice until he died on 25 December 1840; his widow retained a financial interest in the firm. Russell Bros expanded quickly and soon moved to Macquarie Place, where new workshops were erected and stores acquired in Bridge Street.

In 1842 when Robert and John refused an offer to buy James Blanche's foundry Peter decided to take it over. His brothers stipulated that he take only a little of his share of the family capital, and with assistance from his mother he bought the business for £2000 on three-year terms and quickly opened under the name of The Sydney Foundry and Engineering Works. Within two years he had paid off the purchase price and was receiving many orders. He won contracts for the ironwork for Victoria Barracks at Paddington, Darlinghurst Gaol and the Newcastle and Maitland gaols. He had contracts for all the ironwork required by the New South Wales government and the Sydney Municipal Council as well as some private work. He also supplied his brothers with brass and iron castings. They had now branched out into shipbuilding, but a financial collapse resulted in the winding up of Russell Bros and great loss to The Sydney Foundry. Robert went to the Philippines to install plant and equipment and died there in 1849. John assisted Peter for a time then with his financial aid traded in the Pacific, but eventually returned to Sydney.

In 1855 a five-year partnership was formed as P. N. Russell & Co. In 1859 Peter was the resident partner in London, with John Russell and J. W. Dunlop (who had been works foreman) in Sydney and George Russell in Melbourne. The firm flourished as 'Engineers, Founders and Importers'. New premises were built in Pitt Street and workshops extended over a large waterfront area at Darling Harbour with a warehouse in George Street through to York Street. Contracts were received for railway bridges, rolling stock, steam dredges, quartz crushers and flour-mills, also gunboats for the New Zealand government for use in the Maori wars



In 1859 Peter married Charlotte, eldest daughter of Dr Alexander Lorimer, deputy-inspector-general of hospitals at Madras, and returned to Sydney with her. Next year they went back to London where he continued to act as the firm's representative. In Sydney Dunlop was in control until 1863 when he resigned to form a partnership with Norman Selge [q.v.]. After much industrial unrest in 1873-74 P. N. Russell & Co. was closed. John arranged for the sale of the engineering warehouse section and went to London where he died in 1879. Greatly upset by the firm's closure, Peter visited Sydney in 1877 to settle legal matters, but soon returned to England. In 1885 he sold his extensive property in Brisbane and in 1886 visited Australia for the last time.

On 16 December 1895 the Senate of the University of Sydney accepted Russell's gift of £50,000 to the school of engineering and his condition that it be called the 'Peter Nicol Russell School of Engineering'. In 1904 he offered to provide a further £50,000 for engineering scholarships on the agreement of the government to make available £25,000 for additional accommodation. Knighted in June 1904, he died childless on 10 July 1905 at his home in Porchester Gate, London, survived by his wife. His estate in New South Wales was valued for probate at £98,648. He left £13,000 to charitable organizations in Sydney, as well as £3000 to the Engineering Association of New South Wales. On the foundation of the Institution of Engineers, Australia, in 1919 it established the Peter Nicol Russell memorial medal, awarded annually to a member for a notable contribution to engineering in Australia.

Russell's portrait by Sir William Orchardson, R.A., is in the possession of the University of Sydney.

TYPES OF TRUSSES

Before dealing with the engineering significance of the Denison Bridge it would be helpful to the reader to know a little about the basics of trusses and then to receive the history of the other three significant bridges of Bathurst, the Ranken Bridge at Eglinton, the railway bridge over the Macquarie River and the bridge carrying Rocket Street over the railway yard. This will place the Denison Bridge in its contemporary engineering context and help the reader with some of the technical language that must be used when discussing particular details of the that bridge.

Firstly, the types of trusses. The accompanying drawing, figure 10, shows the four most common types of trusses with a typical pattern of loading and with the types of forces generated in the component members. There are a great many variations of these four types of trusses but they are not relevant to this report.

The three types of Warren trusses originated in Britain and Europe and are very common in all British colonies. A local example is the 7-triangular lattice railway bridge, see figure 14 and the paper on Lattice Girder Railway Bridges in NSW in the Appendix.

The Howe and Pratt trusses originated in America during the 1840s and their simple frameworks and other technical features meant that by the turn of the century they became the most commonly used types of trusses.

The Ranken's Bridge is a Howe truss with long timber diagonals in compression and short vertical iron rods in tension.

The Rocket Street and the Denison bridges are Pratt trusses with the long diagonals in tension and the short verticals in compression. Structurally, this is the better arrangement because short vertical columns require less material than long diagonal columns.

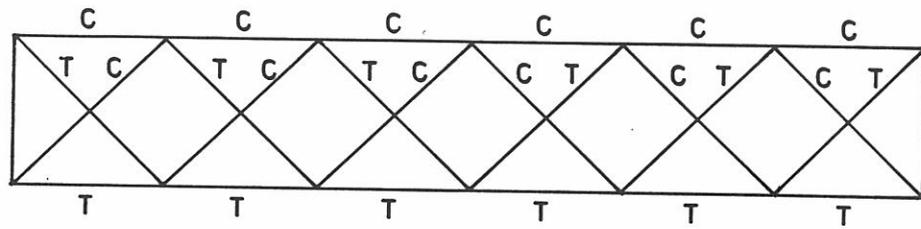
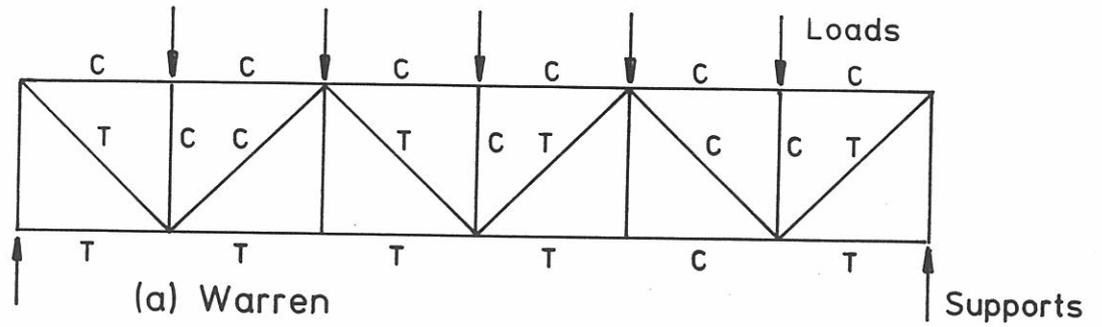

(b) Simple lattice or double Warren

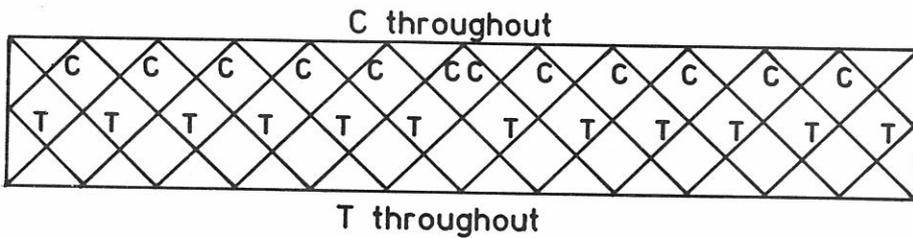

(c) Compound lattice or multiple Warren

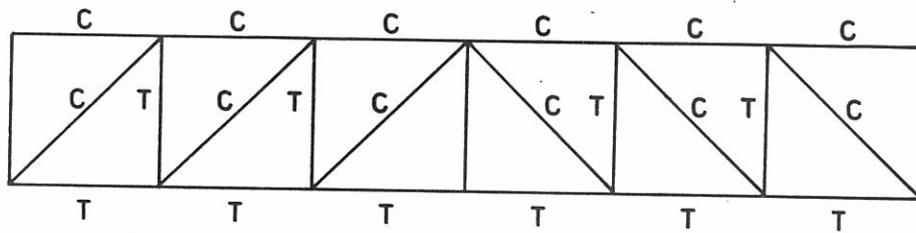

(d) Howe

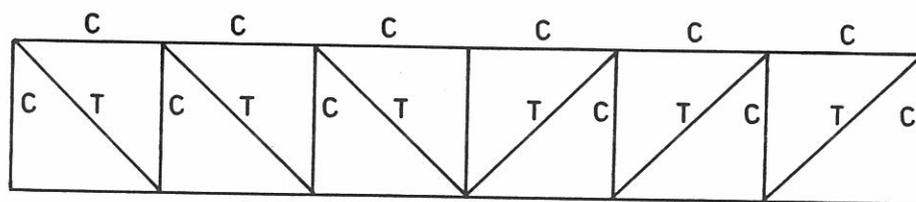

(e) Pratt

C = compression, member acts as a column.

T = tension, member acts as a tie.

THE OTHER COLONIAL BRIDGES

Ranken's Bridge

The first bridge across the Macquarie River to give access to the village of Eglinton and the rich farming country on that side of the river was the private venture by George Ranken (frequently quoted as Rankin). He and Mrs. Ranken had arrived in Bathurst in 1823 and set up home on his grant on Kelloshiel Creek just west of Eglinton. He became a prominent landholder and businessman of the Bathurst district involved in banking, making cheese and brewing, as well as being active in church and civic affairs.

In the Bathurst Free Press of January 5, 1856 George Ranken issued an open invitation for the public opening of his bridge on Saturday 12th, twelve days after the Denison Bridge opening. A full report followed in the issue of January 19 dealing with the event and the refreshments but no details of the bridge.



11. *John Ryan's 1857 painting of Ranken's Bridge.*
(*Bathurst District Historical Society*)

However, John Ryan's painting shows the bridge consisting of two sloping cantilever halves meeting above midstream. The hump at the apex must have been awkward for bullocks and drays but it was better than fording the river. Unfortunately, this bridge suffered the same fate as the Denison Bridge being washed away by the June 1867 flood.

1873 Old Bridge demolished New Bridge erected 1920

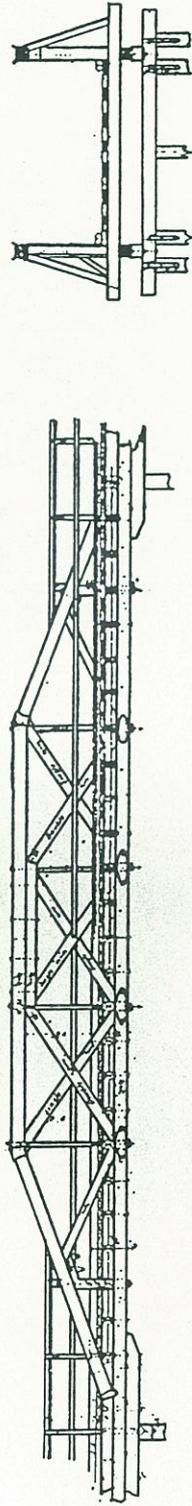
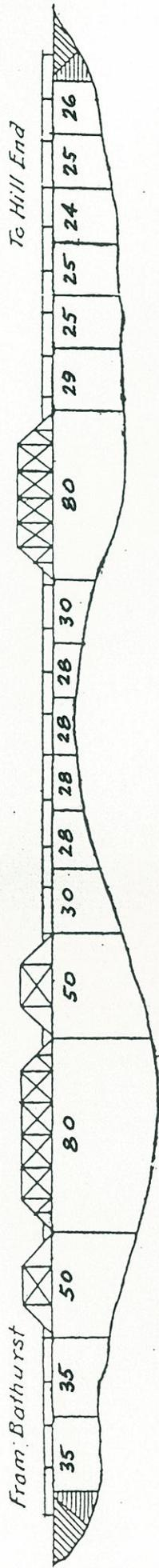

12. Line diagram of the 1873 Ranken's Bridge and an elevation of an "Old FWD" timber truss

The importance of a bridge connecting Bathurst to Eglinton and beyond was such that the Government decided to build a substantial, properly engineered replacement which was completed in 1873. Figure 12 shows a line drawing of the bridge, from an old PWD book held in the RTA Bridge Branch, which indicates that the structure had two parts. The main channel was crossed by three trusses and the adjacent floodway by one truss, and there were timber beam spans linking them plus timber beam approach spans. An elevation of one of the trusses is included in figure 12.

The trusses were a british-european design known then as queen trusses, because of their evolution from queen-post roof trusses, but now referred to as the "old PWD" type. They demonstrated the feasibility of building large-span bridges relatively cheaply using the excellent structural hardwoods from regions such as the North Coast of New South Wales and many bridges incorporating these trusses were built during the 1870s and early 1880s. Unfortunately, there were technical faults in the design that made both construction and long-term maintenance difficult, so they were superseded by J. A. McDonald's design in 1884, see the Timber Bridges paper in the Appendix.

Over the next 80 years all but two of the "old PWD" truss bridges were replaced, among the replacements was Ranken's Bridge in 1919-20.



13. *The present timber truss Ranken's Bridge, completed in 1920.*

But the demise of the "old PWD" design did not mean the abandonment of timber truss bridges, they were too important to the economics of the public works programme. Instead the design underwent a series of refinements by such famous Public Works Department engineers as Percy Allan, E. M. DeBurgh, Harvey Dare and J. J. C. Bradfield. In particular, Percy Allan produced a new design in 1894, based on the American Howe truss, that was so successful in terms of ease of construction and maintenance that it has become known as the Allan truss (Appendix paper). Two of these trusses were built at Eglinton and have been in service for more than 70 years.

The railway bridge

The Great Western Railway reached the Bathurst district on March 4, 1873 at Raglan and then February 4, 1875 at Kelso where the terminus remained for a year while the bridge over the Macquarie River was completed. The official opening of rail services to Bathurst took place on April 4, 1876.



14. *The 1876 railway lattice girder over the Macquarie River, Bathurst.*

The railway bridge, which is still in use, was a typical piece of british bridge technology so much favoured by the railway Engineer-in-Chief, John Whitton. It is a lattice truss (or girder) of which 12 were built in New South Wales, see paper in the Appendix. Currently, the Bathurst railway bridge is the oldest of its type in the system.

Rocket Street bridge

When the railway was extended to Blayney in November 1876, public access from South Bathurst to Vale Road was by a level crossing south-west of the Rocket Street bridge via Bant Street near Hawthornden Creek. Thirteen years later a large iron truss was built over the railway yard at Rocket Street where it reached the top of the railway cutting.



15. Rocket Street overbridge is still regarded as a large-span Pratt truss.

Considering the importance to Bathurst of this bridge, providing uninterrupted traffic movements to the southern parts of the district, it is surprising that there is so little reference to the bridge in the local newspapers. The author has found only two items, a letter on September 7, 1888 complaining that no work had taken place for a year, and a report on November 14 about Commissioner Eddy's visit to Bathurst during which he "first walked down the line to the new bridge being erected".

Some justification for the letter writer's complaint can be gauged from successive Railway Annual Reports which recorded the moneys expended on this project, 467 pounds in 1886 for land (the approaches ?), 1489 pounds in 1887, 2939 pounds in 1888 under the heading "Bathurst, new overbridge", but no reference in the 1889 Report (presumably completed ?). The local papers appear not to have recorded the availability of the bridge for general public use.

The bridge is a 135-foot Pratt truss (review figure 10) with a polygonal or "hog's back" top chord and was built under the supervision of George Cowdery's staff in the Existing Lines Branch, not by John Whitton's staff in the Construction Branch. Three years earlier Cowdery and Whitton had a bitter feud over the quality of Whitton's bridges which Cowdery had to maintain. The dispute led to the 1886 Railway Bridges Inquiry, G. A. Morell of Denison Bridge fame was the President, which found no fault with Whitton's work. But that did not heal the wounds so the two groups of bridge engineers took different directions in applying contemporary bridge technology.

Whitton persisted with british lattice trusses whereas Cowdery encouraged his designers to use of European and American trusses. Examples of the latter were the 98-foot Schweidler truss, figure 16, over Argyle Street, Moss Vale in 1885 (replaced in 1915 by the present bridge) and the 1886 Whipple trusses of 90-foot span at Lewisham, Sydney, which were replaced by plate web girders in October 1993, figure 18.

Then came the Rocket Street bridge completed in 1889, figure 17. Although this bridge is a Pratt truss, a comparison of figures 16 and 17 would suggest that contemporary engineers would simply have regarded the Rocket Street bridge as a larger Schweidler truss.

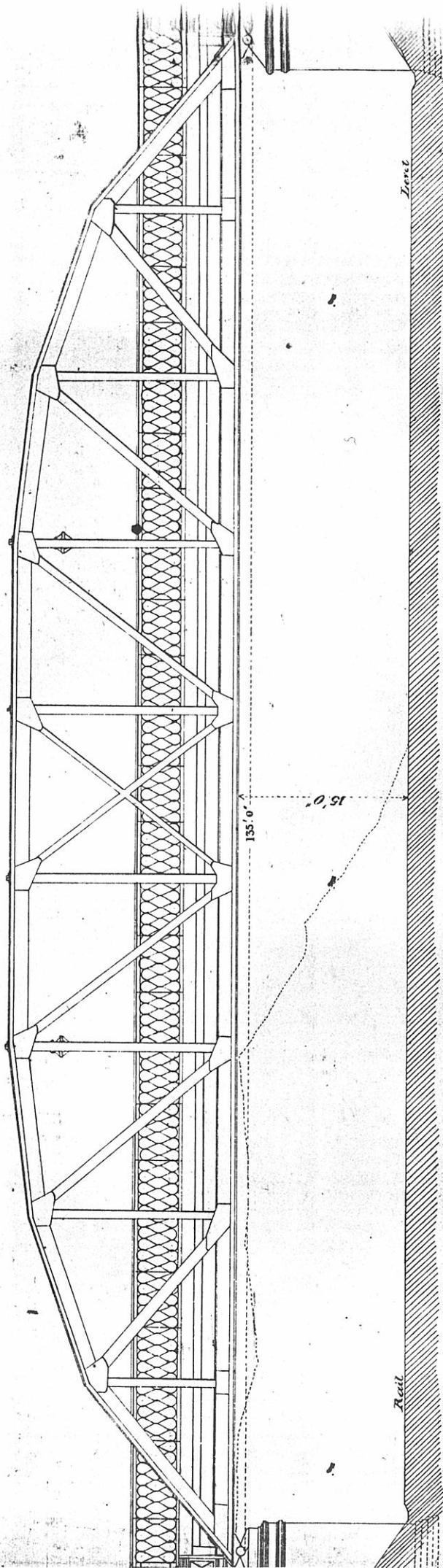

17. Elevation drawing of the Schweidler (Frett) truss over Bethurst railway yard. (SRA plan room)



18. *The disused 1886 Whipple trusses on display at Lewisham, Sydney, after their replacement by plate web girders in October 1993.*

ENGINEERING SIGNIFICANCE OF THE DENISON BRIDGE

There is one other classification of bridges that the reader needs to be aware of before the engineering significance of the 1870 Denison Bridge can be discussed. It concerns three ways of describing the relative positions of the traffic and the bridge structure.

Firstly, the THROUGH bridge which has the main trusses (or girders) tall enough that horizontal cross-bracing can be incorporated to pass above the highest vehicle. Rocket Street bridge is a THROUGH bridge, figure 19. Traffic passes through the bridge as if in a tunnel with open sides.



19. *Interior deck-level view of Rocket Street bridge with its tunnel-like appearance.*

Secondly, the HALF-THROUGH or PONY bridge which has shallower trusses (or girders) such that horizontal cross-bracing would obstruct traffic. The top of the bridge is open. Ranken's Bridge is a PONY bridge, figure 20.

The Bathurst railway bridge, figure 14, is a PONY bridge but has supplementary transverse arches joining the tops of the lattice girder-trusses, tall enough to clear the rail traffic.



20. *Ranken's Bridge is a PONY bridge with trusses not tall enough to provide cross-bracing above the tops of tall vehicles.*

Thirdly, there are DECK bridges in which all their structure is below the traffic deck. The railway Whipple trusses at Lewisham, figure 21, are DECK trusses and the new concrete bridge over the Macquarie River at Bathurst is a DECK box-girder bridge.



21. *The railway tracks on top of the old trusses at Lewisham mean that these structures are DECK bridges.*

The significance of these three classes of bridges relates to the drawing of basic types of trusses, figure 10, and a particular mode of structural failure illustrated in figure 22, called LATERAL BUCKLING.

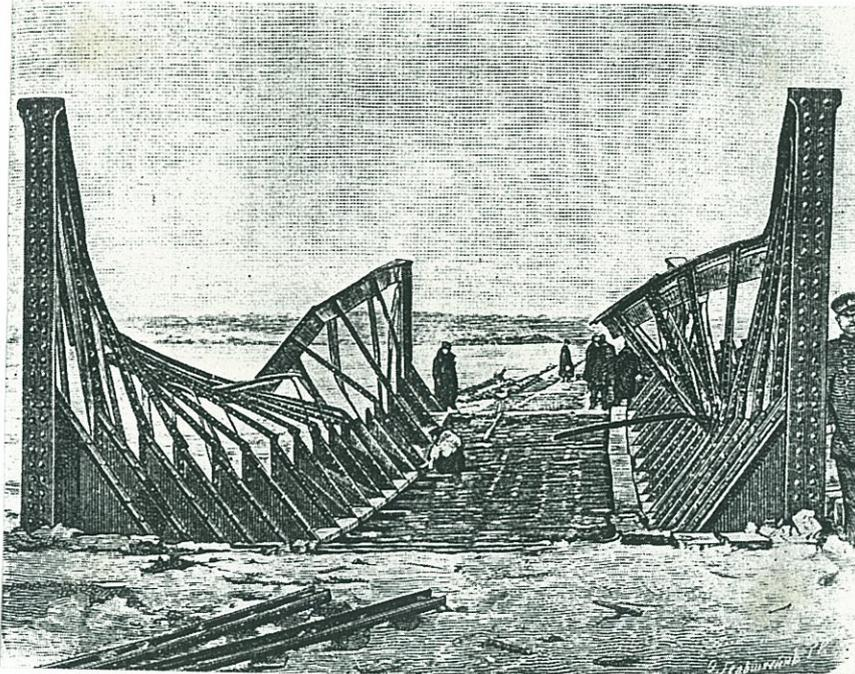

22. *Lateral buckling of OPEN or PONY bridges occurred at several locations in Europe and Russia during the 1870s. (History of Strength of Materials by Timoshenko)*

A review of the basic types of trusses, figure 10, shows that in each case the top member (chord or flange) is entirely in compression, therefore it acts as a column or strut and so is likely to buckle. However, it cannot buckle vertically because the diagonal and vertical members prevent this whereas it could buckle sideways or laterally as shown in figure 22.

For a THROUGH truss the cross-bracing prevents lateral buckling, as does the cross-bracing under the deck of a DECK truss. But the PONY truss, without cross-bracing is vulnerable to a lateral buckling failure.

A long column buckles easily at low loads so ways had to be devised to prevent buckling and increase the strength of the compression member. Bridge engineers have developed a number of ways of achieving this, for example (a) by using a large solid cross-section, heavy and an expensive use of material, (b) by making the top chord into a tube or box, figure 23, which greatly improves the lateral buckling strength, or (c) as was done by G. A. Morell on the Denison Bridge, place an I-shape horizontally so that its natural strength

against bending and buckling is in the horizontal plane where the lateral or sideways buckling takes place.

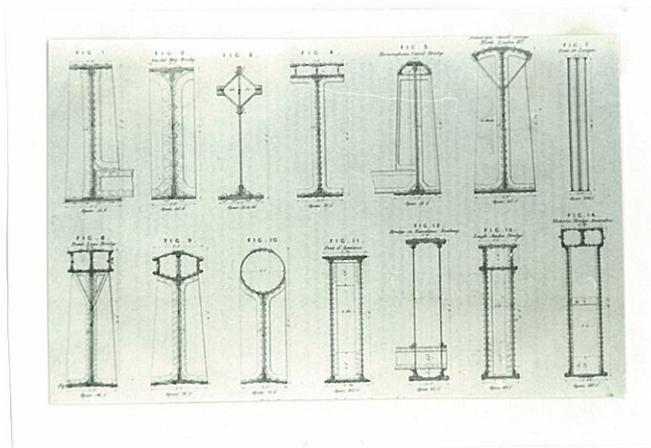

23. *Various forms of top chord tubes and boxes that were used last century and found to prevent lateral buckling even though expensive to fabricate.*



24. *The horizontal I-beam system used by G. A. Morell to prevent lateral buckling of his 1870 Denison Bridge.*

An alternative method for preventing sideways buckling of the top chord is to convert the very long column into a continuous series of short columns. Short columns buckle at much greater loads, so, a series of lateral or sideways supports is incorporated which, in the case of a PONY truss, have to be outside the structure. Ranken's Bridge has these in the form of sloping angle-iron rakers, figure 25.

Morrell's use of the horizontal I-shape is structurally very efficient and is elegant, no external pieces.



25. *External rakers support the top chord of Ranken's Bridge against lateral buckling.*

The theoretical solution to the problem of lateral buckling of compression flanges in bridges was not solved until the 1890s by the engineer-academic F. S. Jasinsky who had only just started his undergraduate degree in St. Petersburg in 1872 at the same time that Morell's Denison Bridge was beginning its 123-year service life.

Clearly, Morell's practical solution in 1868 showed that he understood the mechanics of the failure mode and what was necessary to prevent it. The horizontal I-shape was innovative and cost-effective but was not copied. The preferred solution by most designers has been to use either taller trusses with overhead cross-bracing or deck trusses and, occasionally, pony bridges with external rakers.

The ironwork of the Denison bridge has another interesting feature. Being a Pratt truss, the verticals are columns and are prone to buckling whereas the diagonals are in tension, so they act as ties which do not buckle. Therefore, the verticals need to be stocky robust members in order to resist buckling, but the diagonals can be slender. Morell's details of these two types of structural members show very clearly the different amounts of material to achieve the required strengths, figure 26.

Considering that George Cowdery was introducing the Pratt truss into the New South Wales railway system during 1885-89 (see the section on Rocket Street bridge) indirectly through the use of the Schweidler truss from Europe, and John Whitton would only use British bridge technology, it is all the more remarkable that twenty years earlier Gustavus Morell adopted a truly American form of the Pratt truss for the Denison Bridge.



26. *The truss members of the Denison Bridge. The diagonal tension ties are simply made from parallel strips of flat iron cross-braced to dampen vibrations. The compression verticals are made from four pieces of angle-iron, one in each corner of a rectangle and the whole is strongly braced together. The tension bottom chord comprises parallel flats.*

CONCLUSION

This nomination of the 1870 Denison Bridge at Bathurst has discussed the relationship of the bridge to the history of Bathurst as well as to the three other important colonial bridges of the city and district. Its position in the history of bridges has been indicated together with its place in the historical application of structural engineering theory.

The bridge is highly significant both in terms of the science of bridge engineering and its social benefit to Bathurst and New South Wales.

It is Classified by the National Trust (NSW) and is on the Interim List of the Register of the National Estate, and is worthy of a being nominated for a commemorative engineering heritage plaque.

The fact that the bridge has been bypassed by a new bridge nearby means that Bathurst City Council has a unique asset, a bridge of high heritage value, in good order, virtually as originally constructed and in its original place. Therefore, preservation and long-term upkeep should not be a financial burden to the community, and its location near to other civic amenities offers the potential for the bridge to still carry foot and cycle traffic. Council has received professional advice from consulting engineers Irwin Johnston and Partners on formulating plans about the preservation of the bridge.

Bathurst is justly proud of its colonial history which is reflected in the quality of its built environment surviving from that era, particularly the many fine examples in architecture. But the development of the city has been influenced as much by its engineering infrastructure as by its buildings. For example, roads, the railway and the associated bridges have all played an important part in that development.

With the preservation and plaquing of the 1870 Denison Bridge, Bathurst City Council has a great opportunity to highlight and promote one of its longest serving items of public works.

APPENDIX

DESIGN FOR AN IRON BRIDGE OVER THE MACQUARIE RIVER

William H. Barrett
Commissioner of Engineers

at
BANKHURST.
 Scale 8 ft. to 1 in.



GENERAL ELEVATION

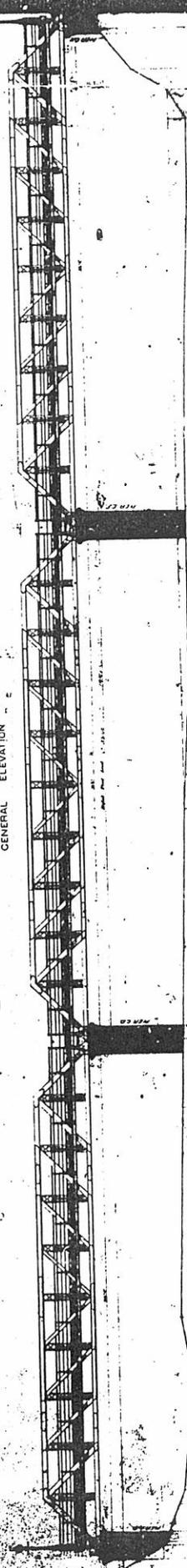

PLAN

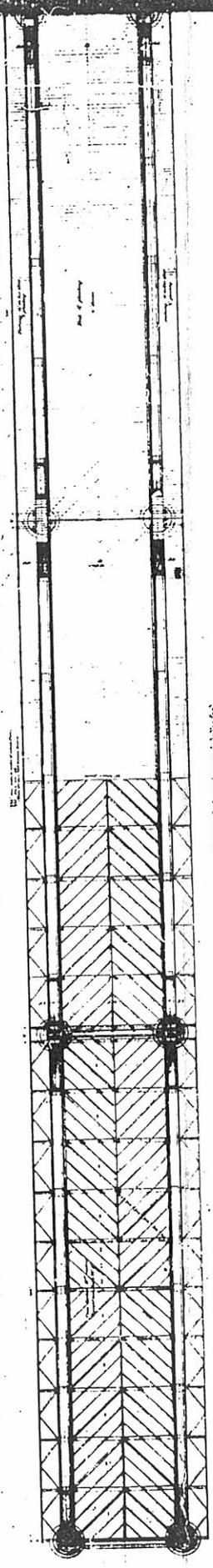

Scale for Sections 1 in. = 20 ft.

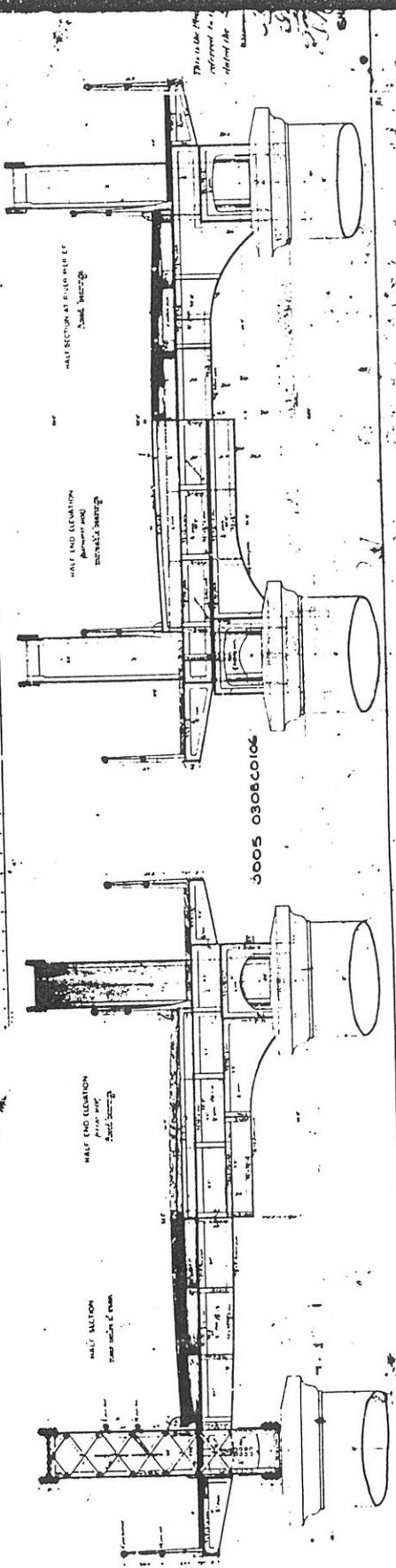

HALF END ELEVATION
 APPROX. 1/20

HALF END ELEVATION
 APPROX. 1/20

HALF SECTION AT PIER PER ET
 SCALE 1/20

3005 03080106

W. H. Barrett
Chief Eng.
 10/1/88

Sheet 1 of 7
 Plans 1 of 2

BATHURST BRIDGE DETAILS OF MAIN GIRDER

William Blackwell
Commissioner of Highways, N.S.W.

N^o 3
This is the Plan marked with the letter
referred to in my Report to the Hon. the
Attorney General, dated the 25th April 1904, and
marked "A".

Wm. Blackwell
John Blackwell
John Blackwell
John Blackwell
John Blackwell

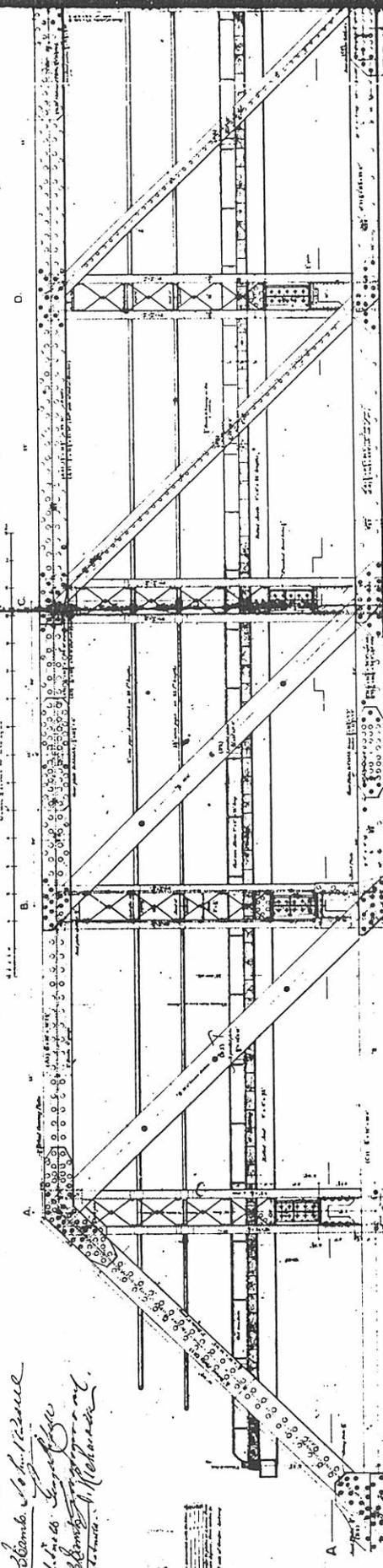

PLAN OF COMPRESSION MEMBER AND END STRUT
AND DEVELOPMENT OF PLATES OF ONE SIDE

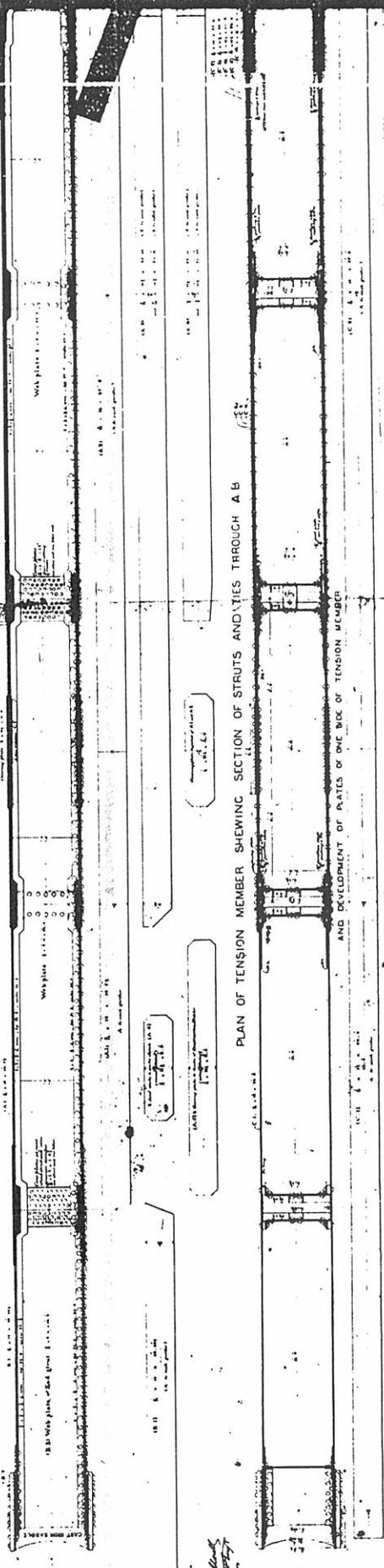

PLAN OF TENSION MEMBER SHOWING SECTION OF STRUTS AND RIVETS THROUGH A B
AND DEVELOPMENT OF PLATES OF ONE SIDE OF TENSION MEMBER

0005 03060104
SHEET 3 OF 7

BATHURST BRIDGE

DETAILS OF MAIN GIRDER

SCALE 1/4" = 1' TO THE FOOT

N^o 4.

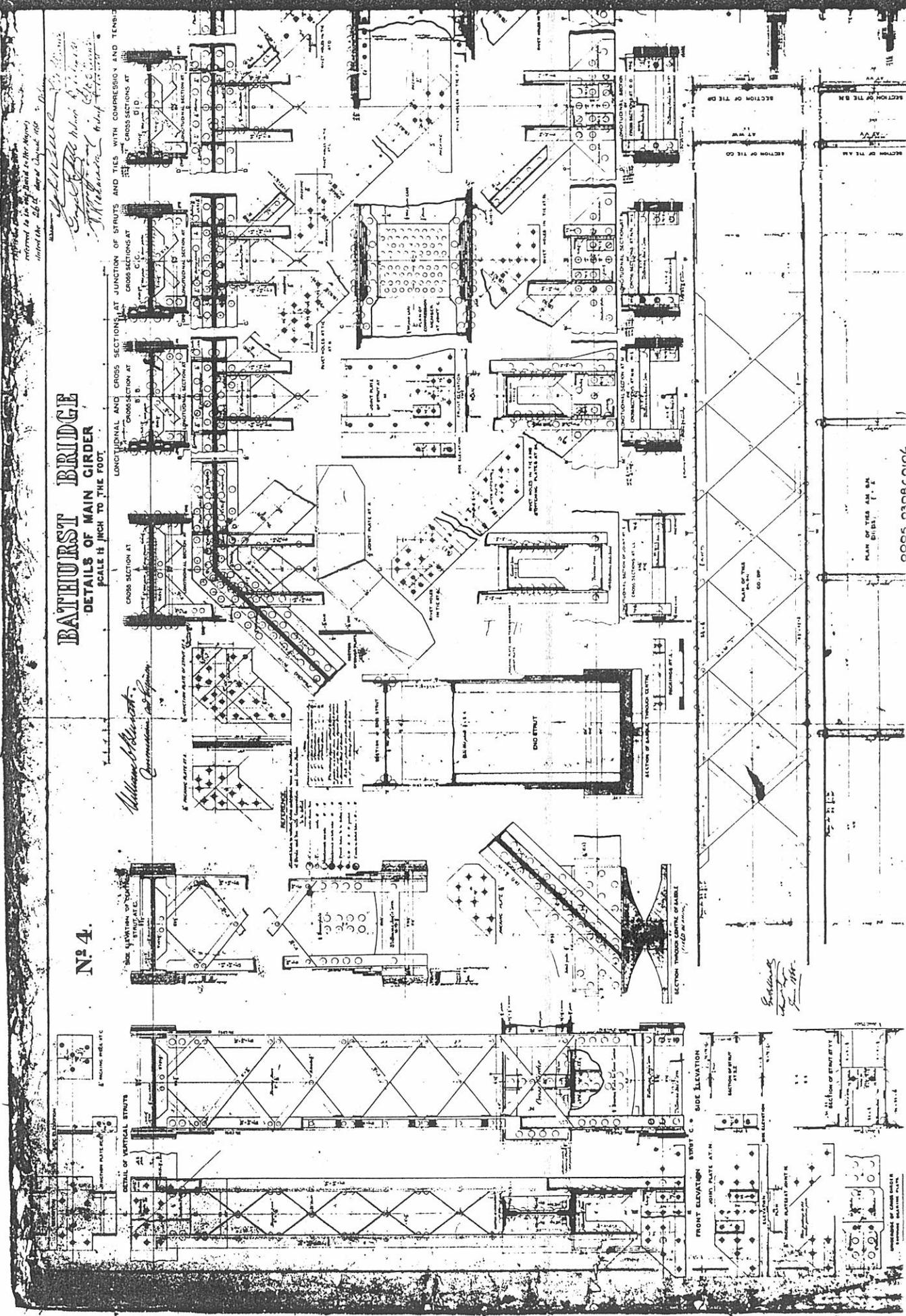

BATHURST BRIDGE

Details of Cross Girders and Bracing Beams over Piers

William Roberts
 Commissioner of Public Works
 Bathurst, N.S.W.

N.5. Half pier of Abutment
 (Rise Side)
 Half Bridge between Abutment

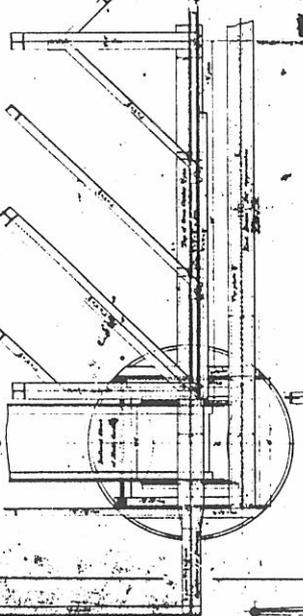

Half Elevation

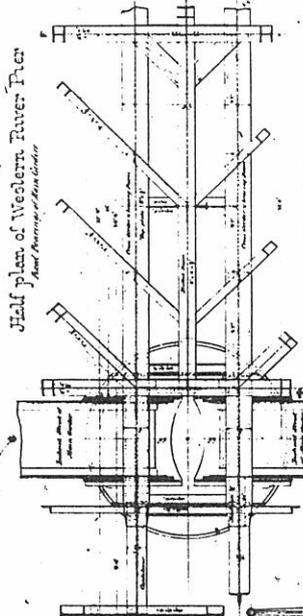

Half pier of Western River Pier
 (Rise Side)
 Half Bridge between Piers

Section at H.H.

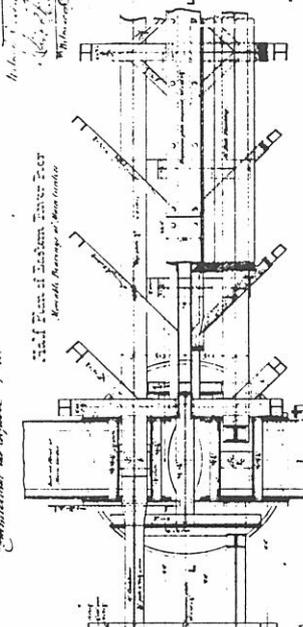

Half pier of Eastern River Pier
 (Rise Side)
 Half Bridge between Piers

Section at L.L.

Cross Section
 at A. A. (Rise Side)



Elevation of Cross Girder over Pier (Rise Side)

FRAME for 2

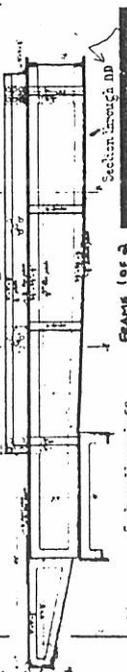

Section through CC

Exchange Section



0005 0308-0106
 SHEET 5 OF 7

Longitudinal Section at G.G.
 Longitudinal Section over Pier at G.G.

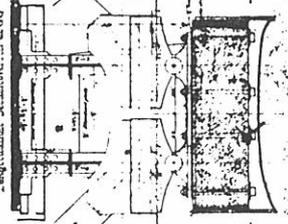

Section through DD

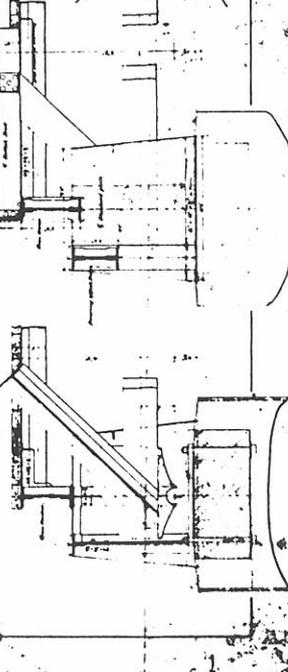

Longitudinal Section at M.M.
 Longitudinal Section over Pier at M.M.

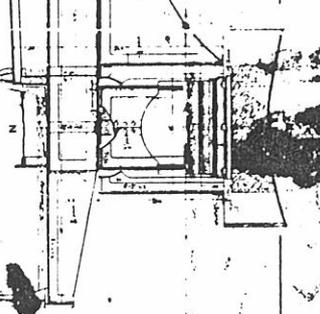
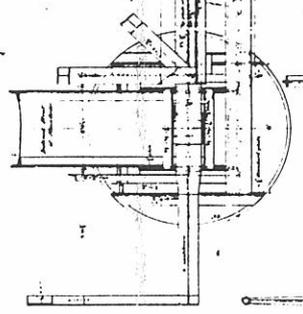
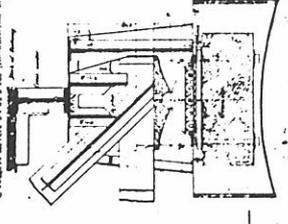

Scale
 1/4" = 1'-0"

Notes
 1. All rivets to be of the best quality.
 2. All bolts to be of the best quality.
 3. All steel to be of the best quality.
 4. All work to be done in accordance with the specifications.

W. Roberts
 Commissioner of Public Works

BATHURST BRIDGE

Details of Top Cylinders and Filling Lengths.

SCALE 1 inch = 1 foot.

N 7

Details of Cylinders



PLAN OF FITTING LENGTHS FOR C.

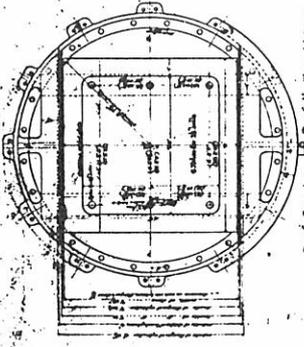

PLAN OF STONES FOR BEDLAYS

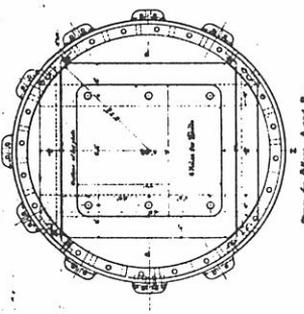

PLAN OF FITTING LENGTHS FOR B.

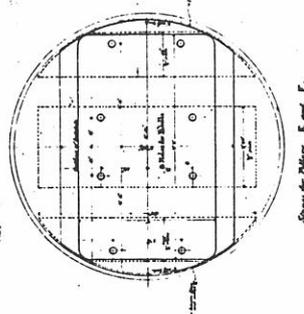

PLAN OF FITTING LENGTHS FOR A.

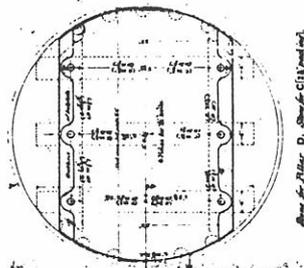

SECTION OF C.

SECTION OF B.

SECTION OF A.

SECTION OF D.

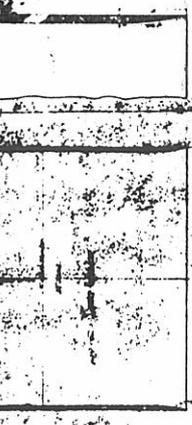

SECTION OF E.

SECTION OF F.

SECTION OF G.

SECTION OF H.

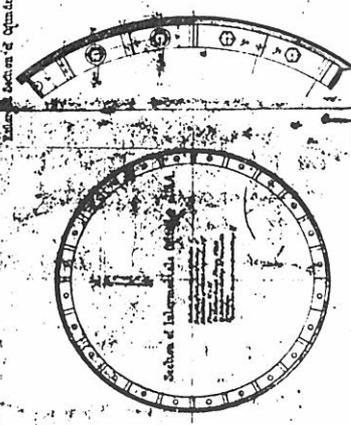

SECTION OF I.

SECTION OF J.

SECTION OF K.

SECTION OF L.

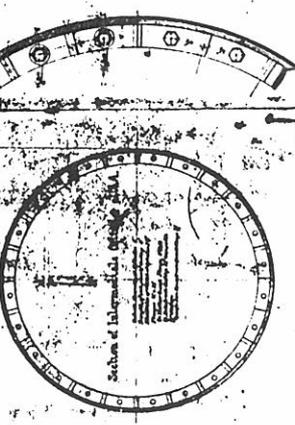

SECTION OF M.

SECTION OF N.

SECTION OF O.

SECTION OF P.

0005 0308C0106
SHEET 7 OF 7

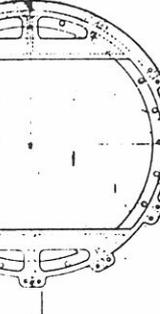
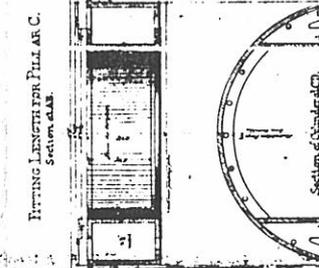
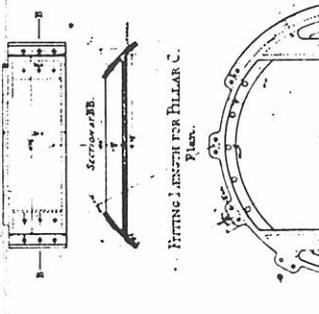
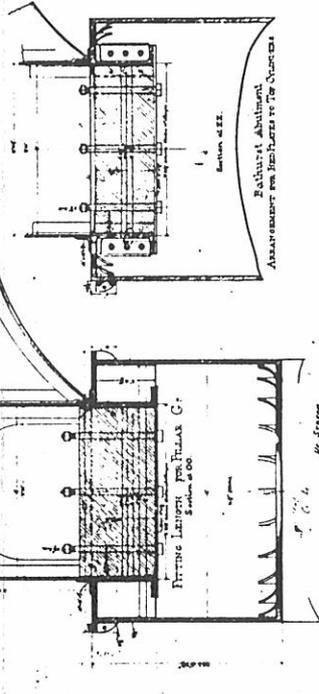

Swift Repairs to Bathurst's Battered Bridge

Ross Smith, Lithgow Divisional Office.

The historic 120-year old Denison Bridge, which carries the Great Western Highway over the Macquarie River at Bathurst, was seriously damaged on a busy Friday afternoon in March.

The damage occurred when an eastbound low-loader hauling a bulldozer moved too far to one side and the dozer's blade severely damaged seven of the bridge's truss members. Shortly after the accident, Bathurst City Council engineers closed the crossing, their fears being that the bridge was in danger of collapse.

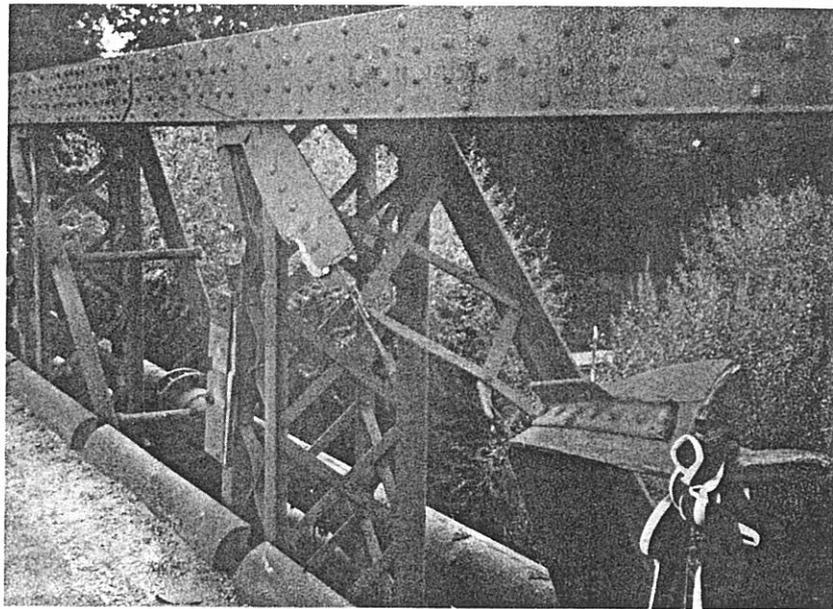

With the closure, it became necessary to detour all traffic along Council roads. Heavy vehicles in particular had a 15 km extra journey through Eglinton to use a bridge which could support their weight, while light vehicles had a 3 km extra trip through Kelso across a one-way bridge with a 5 tonne weight restriction.

On the afternoon of the accident, RTA bridge experts flew to Bathurst from Sydney by helicopter to inspect the structure. Their diagnosis confirmed the original suspicions that the bridge was incapable of supporting heavy vehicles.

It was encouraging to see how readily people responded to this sudden emergency ... in particular, the Police and State Emergency Services (SES), who undertook traffic control duty on the Highway and on the local streets through Eglinton and Kelso which became the alternate through route. Their concerted actions assisted in keeping delays and inconvenience to the travelling public to a minimum ... as well as in preventing motor vehicle accidents.

For sports fans, the bridge's closure could not have been more inopportune, as that evening a televised football match between Penrith and Wests was being held in Bathurst. The bridge closure resulted in game attendance being down on the expected numbers as many fans, caught on the other side of the river in traffic queues, opted to go home rather than arrive after kick-off.

A special meeting held in Bathurst between Police, Council, SES and RTA representatives discussed ways of improving traffic flow during the bridge closure. As a result, peak hour relief to traffic commenced on the following Wednesday by allowing westbound light vehicles to use one lane of the Denison Bridge between 7.30 am and 9.30 am and 3.30 pm to 6.00 pm, Monday to Friday. Portable traffic signals and a temporary street closure were also used to improve traffic flow ... with Police and the SES maintaining traffic control duty. These special arrangements proved most successful and were well accepted by the travelling public.

History Makes a Tough Task Tougher

On an historical note, a Bicentennial plaque on the bridge records that "Drawings and detailed calculations for this half-through Pratt truss bridge were prepared by Gustavus Morrell, Asst. Engineer under Commissioner for Roads, William Bennett. It replaced an 1856 timber structure opened by and named after Governor Sir William Denison ... and washed away in 1867. Built by Messrs Peter Nicol Russell & Co, using both local and overseas iron, this bridge was opened in June 1870 when the Governor, Earl of Belmore, crossed in his carriage."

From that time, Denison Bridge has been the main thoroughfare for increasing traffic volumes using the Great Western Highway in and out of Bathurst. The uniqueness of the bridge

caused several options for repairs to be discussed before a final decision could be reached. It was also necessary to develop repair methods and carry out design checks to confirm how the bridge's structural strength would be affected as groups of rivets were removed.

The repair work required the removal of eleven ends of damaged iron truss members that had been rivetted tightly between other iron members. Each of these operations proved difficult, and the removal of one tightly-wedged end took almost an entire day.

Seven damaged members were replaced by fabricated plates or angles. The new members had to fit accurately into the bridge truss and were bolted into place with high tensile bolts. Numerous damaged lattice type bracing pieces also had to be replaced by new fabricated pieces and bolted to the new members.

The intricate and difficult bridge repair work was carried out by our Lithgow Division's bridge gangs, organised and supervised by Foreman Garry Dennis.

Fortunately, replacement members did not have to be shipped from England and hauled across the Blue Mountains like some of the originals were! In fact, a local engineering firm, Carter Bros. Engineering of Kelso, fabricated all the replacement members and assisted with specialised drilling. Carter Bros personnel often worked late into the night to prepare members for the next day.

Thanks to the hard work and long

hours put in by bridge engineers and our gangs — and the valuable assistance given by Carter Bros — the problems associated with the complex repair work were overcome much earlier than expected ... and Denison Bridge was re-opened to all traffic only 9 days after the accident. It was fitting that Division Engineer, Bob Wood, was able in a television interview to publicly thank all concerned for getting the bridge re-opened ahead of the expected date.

Such is the quality of the repair work that, when the final coat of paint was applied to the new sections, matching the colour of the existing bridge, it was virtually impossible to tell the new work from the original.

It has long been recognised that the Denison Bridge is inadequate to meet the demands of increasing traffic. Consequently, a new four-lane bridge is under construction (together with new approach work) and is expected to be completed by April 1991. We'll give you more details in a forthcoming issue.

"What's going to happen to the old bridge?"; I hear you ask. Well, you can relax, as the old structure will undergo a pleasant and well-earned career change. When the new bridge is open to traffic, Bathurst City Council will take over responsibility for Denison Bridge and it will be set aside for the exclusive use of pedestrians and cyclists. In this new capacity, Denison Bridge will provide a valuable and continuing contribution to the quality of life both of residents and visitors in the beautiful City of Bathurst.